

## 28/410 DISC TOP CAP

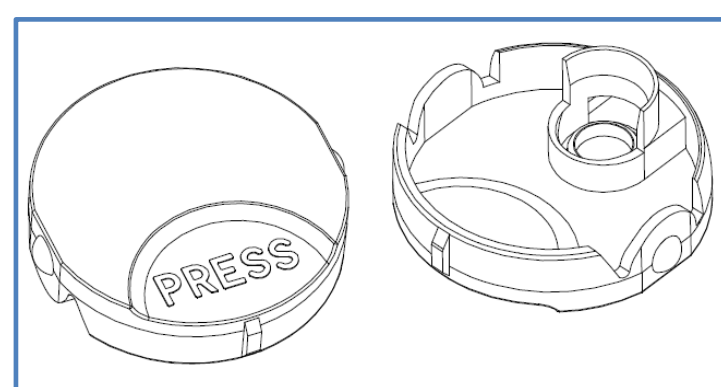
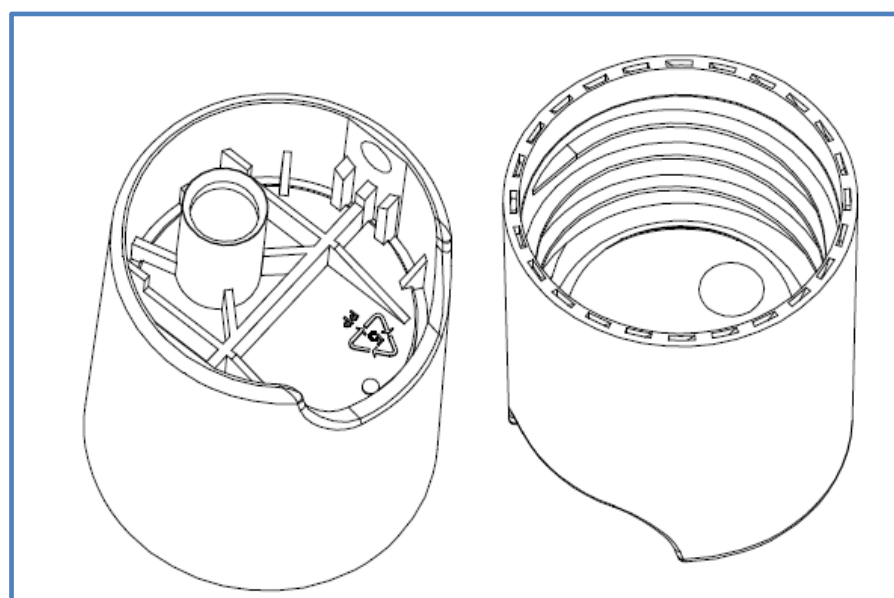
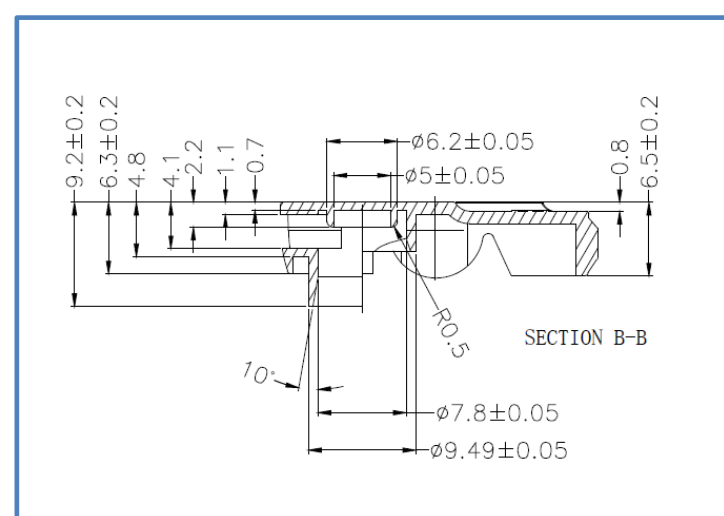
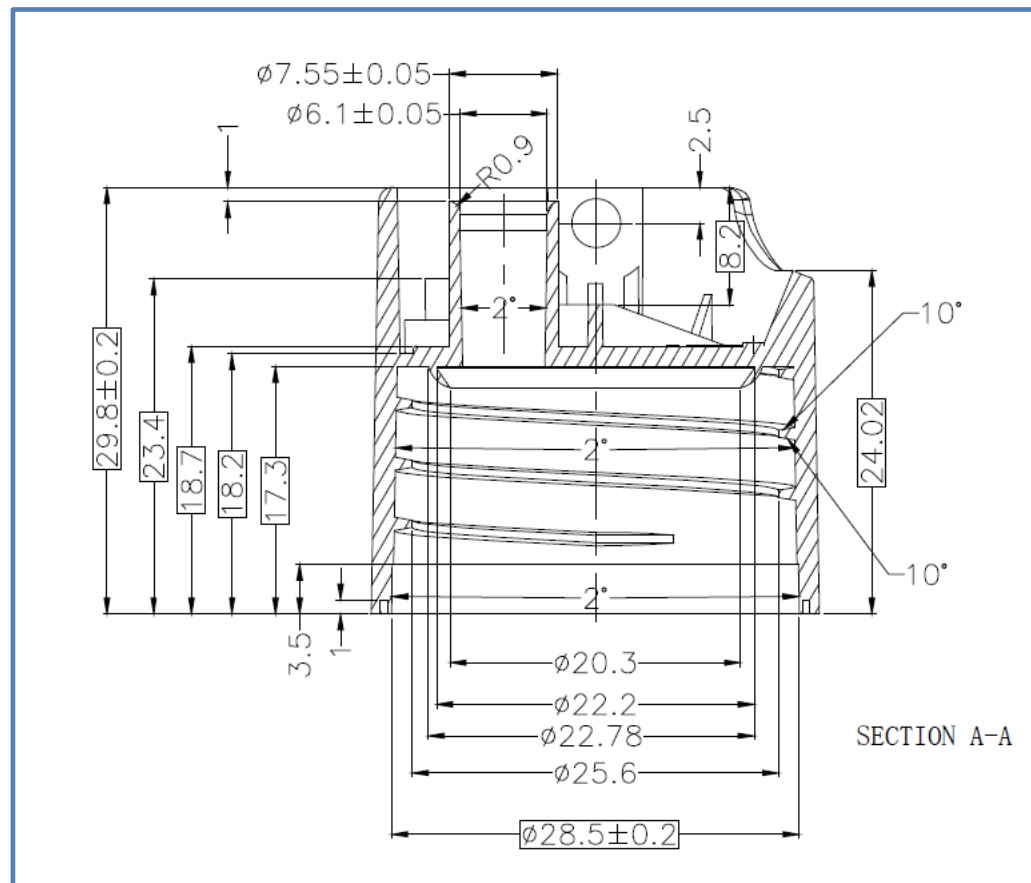

S. NO	DESCRIPTION	SPECS	TOLLERANCE
1	WEIGHT	5.83	±0.20
2	TOTAL HEIGHT	29.8	±0.20
3	THREAD DIA	25.6	±0.20
4	CAP DIA	31.3	±0.20
5	DISC HEIGHT	9.2	±0.20